

## Latch, Hall-Effect Magnetic Position Sensor

### 1 Product Description

The MT856X family is produced by BCD technology with both high performance and high reliability. The Hall IC internally includes an on-chip Hall voltage generator, a voltage regulator for operation with supply voltage of 3.0V to 24V, temperature compensation circuitry, small-signal amplifier, Hall IC with dynamic offset cancellation system, Schmitt trigger and open drain output. It also includes an clamp diode at output and reversed power supply protection enhances the robustness of Hall IC.

When the magnetic flux density (B) is greater than the operating point (BOP), the output turns on (Low). The output is held steady till the magnetic flux density (B) is less than the releasing point (BRP), at which point it turns off (High).

The MT856X family provides a variety of packages to customers: SOT-23/SOT-23 (Thin Outline) for surface mount and flat TO-92 for through-hole mount. All packages are RoHS compliant.

### 2 Features

- BCD Technology
- Latch Switch
- 3.0~24V Operating Vcc Range
- -40°C~150°C Operating Temperature
- Package Option:
  - Flat TO-92
  - SOT-23
  - SOT-23 (Thin Outline)
- Magnetic Sensitivity Option:
  - MT8562 (BOP=20Gs, BRP=-20Gs)
- Open Drain Output
- -16V Reversed Power Supply Protection
- Output Limiting Current Protection
- RoHS Compliant: (EU)2015/863

### 3 Product Overview of MT856X

| Part No. | Description                                      |
|----------|--|
| MT856XA  | Flat TO-92, bulk packaging (1000pcs/bag)         |
| MT856XAT | SOT-23, tape & reel (3000pcs/bag)                |
| MT856XET | SOT-23 (Thin Outline), tape & reel (3000pcs/bag) |

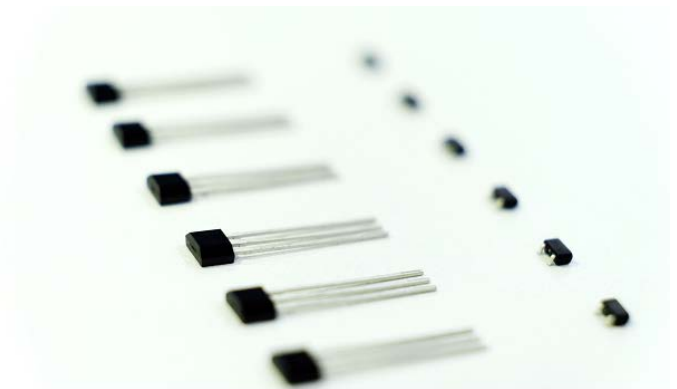

### 4 Applications

- Home appliances, Industrial
- Position Detection
- Magnetic Encoder
- Proximity Switch

### 5. Pin Configuration and Functions

|                       | Vcc   | Out        | GND    |
|-----------------------|-------|------------|--------|
| SOT-23                | 1     | 2          | 3      |
| SOT-23 (Thin Outline) | 1     | 2          | 3      |
| Flat TO-92            | 1     | 3          | 2      |
| Description           | Power | Open Drain | Ground |

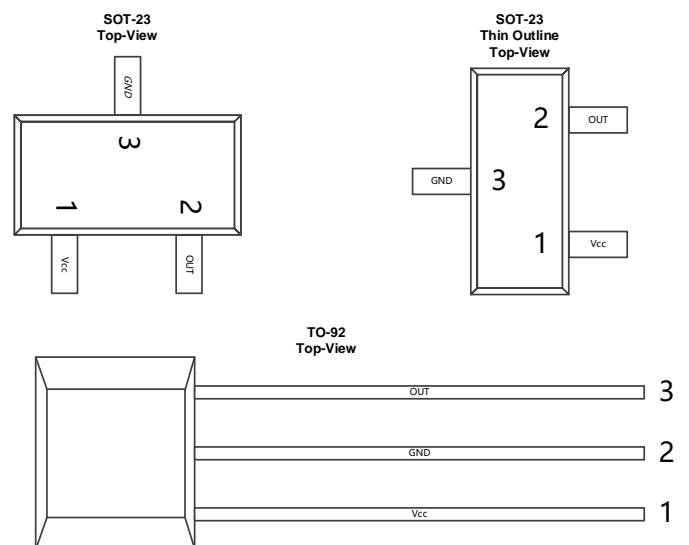

Figure.1 Pin Configuration & Functions

## Table of Contents

|    |   |    |
|----|---|----|
| 1  | Product Description.....                            | 1  |
| 2  | Features.....                                       | 1  |
| 3  | Product Overview of MT856X .....                    | 1  |
| 4  | Applications.....                                   | 1  |
| 5  | Pin Configuration and Functions.....                | 1  |
| 6  | Definition of Switching Function.....               | 3  |
| 7  | Function Description.....                           | 3  |
| 8  | Feature Description.....                            | 3  |
| 9  | Functional Block Diagram.....                       | 4  |
| 10 | Electrical and Magnetic Characteristics.....        | 4  |
|    | 10.1 Absolute Maximum Ratings.....                  | 4  |
|    | 10.2 Electrical Specifications.....                 | 5  |
|    | 10.3 Magnetic Characteristics.....                  | 5  |
|    | 10.4 ESD Ratings.....                               | 5  |
|    | 10.5 Characteristic Performance.....                | 6  |
|    | 10.6 Typical Output Waveform.....                   | 7  |
| 11 | Typical Application Circuit.....                    | 7  |
| 12 | Package Material Information.....                   | 8  |
|    | 12.1 SOT-23 Package Information.....                | 8  |
|    | 12.2 SOT-23 (Thin Outline) Package Information..... | 9  |
|    | 12.3 Flat TO-92 Package Information.....            | 10 |
| 13 | Copy Rights and Disclaimer.....                     | 11 |

## Reversion History

|   |                    |   |
|---|--------------------|---|
| 1 | Originally Version |   |
| 2 | 1.1 Version        | Update Copy Rights and Disclaimer                         |
| 3 | 1.2 Version        | Update the marking spec of SOT-23 & SOT-23 (Thin Outline) |
| 4 | 1.3 Version        | Update the Logo of MagnTek                                |

## 6 Definition of Switching Function

Figure.2 & Figure.3 shows the device functionality and hysteresis

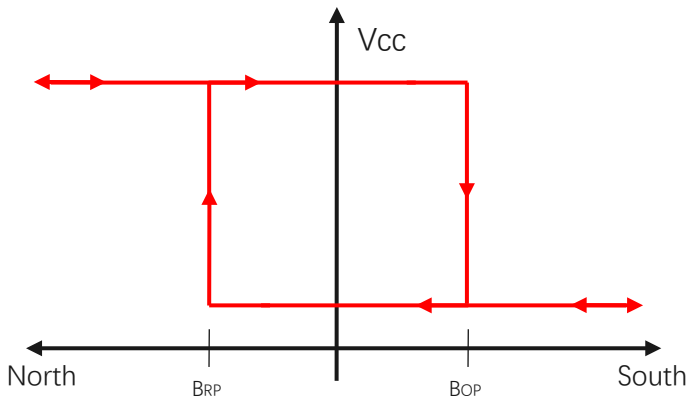

Figure.2 Switching Function of Flat TO-92 & SOT-23 (Thin Outline)

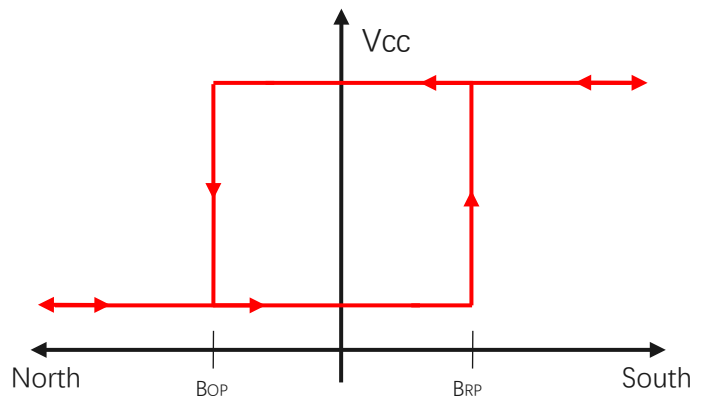

Figure.3 Switching Function of SOT-23

## 7 Function Description

**B<sub>OP</sub>:** Operating Point, Magnetic flux density applied on the branded side of the package which turns the output driver ON ( $V_{OUT}=Low$ )

**B<sub>RP</sub>:** Releasing Point, Magnetic flux density applied on the branded side of the package which turns the output driver OFF ( $V_{OUT}=High$ )

**B<sub>HYST</sub>:** Hysteresis Window,  $|B_{OP} - B_{RP}|$

Devices that have a lower magnetic threshold ( $V_{OUT}=High$ ) detect magnets at a farther distance. Higher thresholds ( $V_{OUT}=Low$ ) generally require a closer distance or larger magnet.

## 8 Feature Description

The MT856X device is sensitive to the magnetic field component that is perpendicular to the top of the package

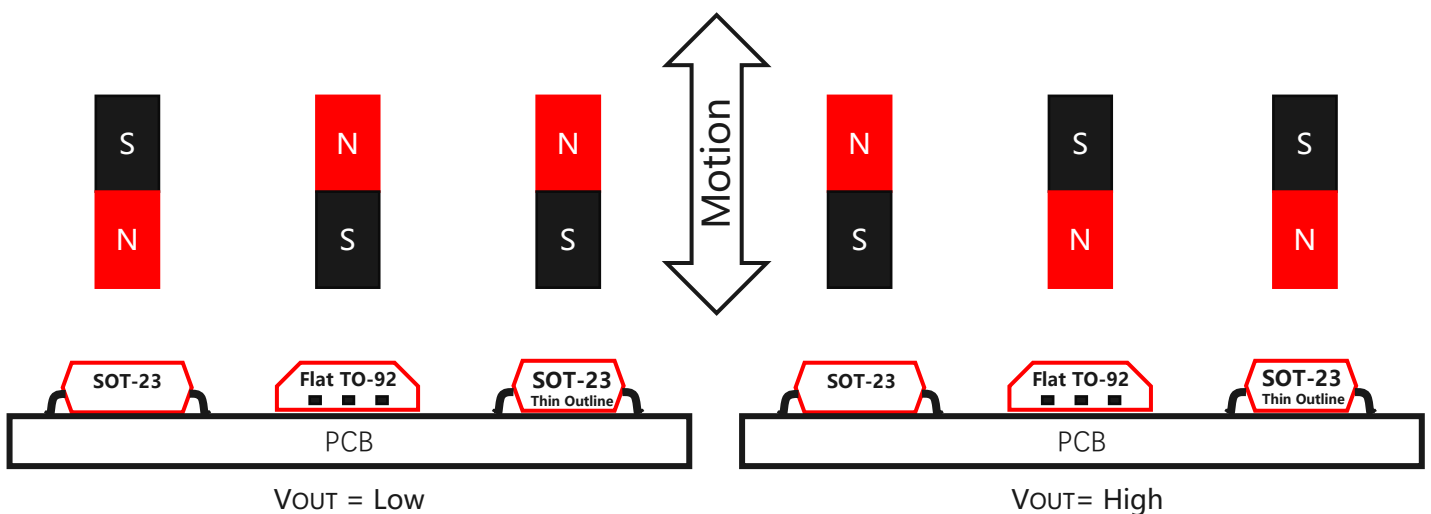

Figure.4 Flux Direction Polarity

## 9 Functional Block Diagram

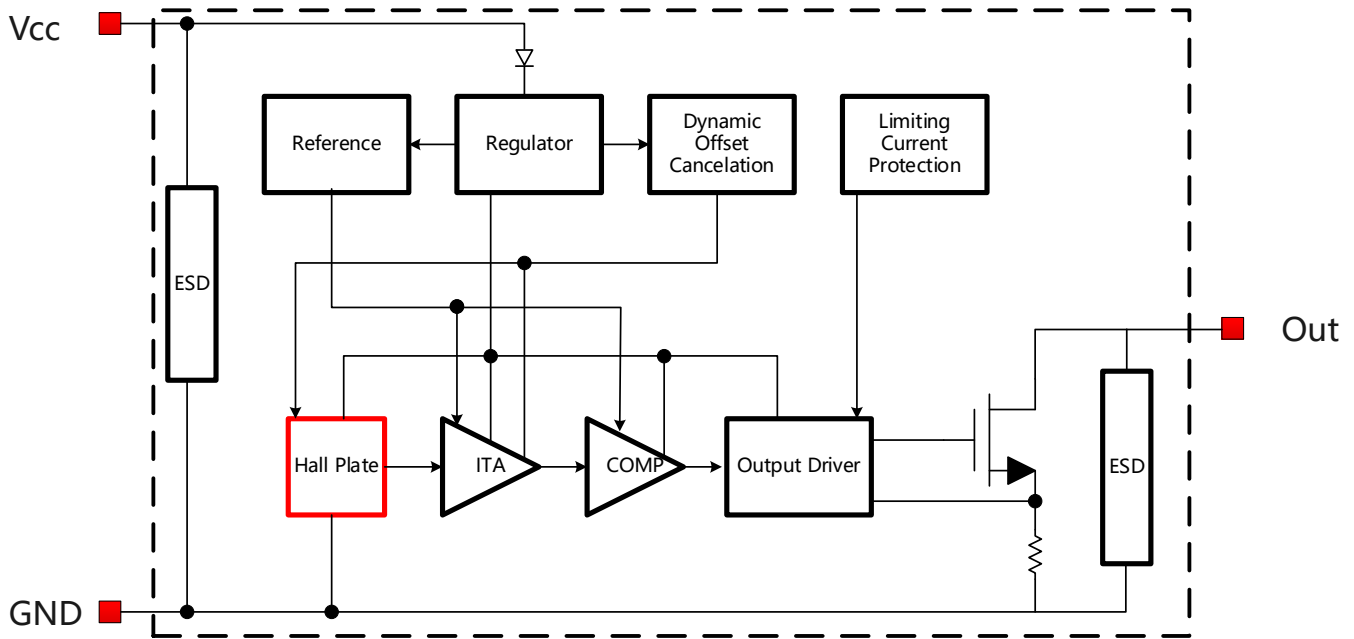

Figure.5 Functional Block Diagram

## 10 Electrical and Magnetic Characteristics

### 10.1 Absolute Maximum Ratings

Absolute maximum ratings are limited values to be applied individually, and beyond which the serviceability of the circuit may be impaired. Functional operability is not necessarily implied. Exposure to absolute maximum rating conditions for an extended period of time may affect device reliability.

| Symbol | Parameters                    | Min      | Max | Units |
|--------|-------------------------------|----------|-----|-------|
| VCC    | Supply Voltage                | -        | 30  | V     |
| VRCC   | Reverse Battery Voltage       | -16      | -   | V     |
| VOUT   | Output Voltage                | -        | 30  | V     |
| IOUT   | Continuous Output Current     | -        | 55  | mA    |
| TA     | Operating Ambient Temperature | -40      | 150 | °C    |
| TS     | Storage Temperature           | -50      | 150 | °C    |
| TJ     | Junction Temperature          | -        | 165 | °C    |
| B      | Magnetic Flux Density         | No Limit |     | Gs    |

## 10.2 Electrical Specifications

At  $T_A = -40 \sim 150 \text{ }^\circ\text{C}$ ,  $V_{CC} = 3.0\text{V} \sim 24\text{V}$  (unless otherwise specified)

| Symbol     | Parameters                                  | Test Condition  | Min | Typ | Max | Unit                      |
|------------|---|---|-----|-----|-----|---------------------------|
| $V_{CC}$   | Supply Voltage                              | Operating   | 3.0 | -   | 24  | V                         |
| $I_{CC}$   | Supply Current                              | $B < B_{RP}$  | -   | 1   | 1.5 | mA                        |
| $I_{OCP}$  | Short Circuit Protection Current            | $B > B_{OP}$ ,<br>$V_{OUT} = V_{CC}$                              | -   | 50  | -   | mA                        |
| $V_{DSON}$ | Output Saturation Voltage                   | $I_{OUT} = 20\text{mA}$ ,<br>$B > B_{OP}$                         | -   | -   | 0.4 | V                         |
| $I_{OFF}$  | Output Leakage Current                      | $V_{OUT} = 24\text{V}$ ,<br>$B < B_{RP}$                          | -   | -   | 10  | $\mu\text{A}$             |
| $T_R$      | Output Rise Time                            | $C_L = 20\text{pF}$   | -   | -   | 1.0 | $\mu\text{s}$             |
| $T_F$      | Output Fall Time                            | $C_L = 20\text{pF}$   | -   | -   | 1.0 | $\mu\text{s}$             |
| $T_{PO}$   | Power on Time                               | $dV_{CC}/dt > 5\text{V}/\mu\text{s}$<br>$B > B_{OP} (\text{MAX})$ | -   | -   | 15  | $\mu\text{s}$             |
| $F_C$      | Chopping Frequency                          |   | -   | 400 | -   | KHz                       |
| $F_S$      | Sampling Frequency                          |   | -   | 25  | -   | KHz                       |
| $R_{TH}$   | Thermal Resistance of SOT-23                |   | -   | 301 | -   | $^\circ\text{C}/\text{W}$ |
|            | Thermal Resistance of SOT-23 (Thin Outline) |   | -   | 301 | -   | $^\circ\text{C}/\text{W}$ |
|            | Thermal Resistance of TO-92                 |   | -   | 230 | -   | $^\circ\text{C}/\text{W}$ |

## 10.3 Magnetic Characteristics

At  $V_{CC} = 3.0\text{V} \sim 24\text{V}$  (unless otherwise specified)

| Part No.      | Symbol                                | Min | Typ | Max | Unit |
|---------------|---------------------------------------|-----|-----|-----|------|
| MT8562 Series | $B_{OP}$ , $T_A = 25^\circ\text{C}$   | 10  | 20  | 30  | Gs   |
|               | $B_{RP}$ , $T_A = 25^\circ\text{C}$   | -30 | -20 | -10 | Gs   |
|               | $B_{HYST}$ , $T_A = 25^\circ\text{C}$ | 20  | 40  | 60  | Gs   |

## 10.4 ESD Ratings

| Symbol    | Reference                  | Level        | Unit              |
|-----------|----------------------------|--------------|-------------------|
| $V_{ESD}$ | Human-body model (HBM)     | AEC-Q100-002 | Class H2<br>Grade |
|           | Charged-device model (CDM) | AEC-Q100-011 | Class C3<br>Grade |

### 10.5 Characteristic Performance

At  $V_{CC}=5V$

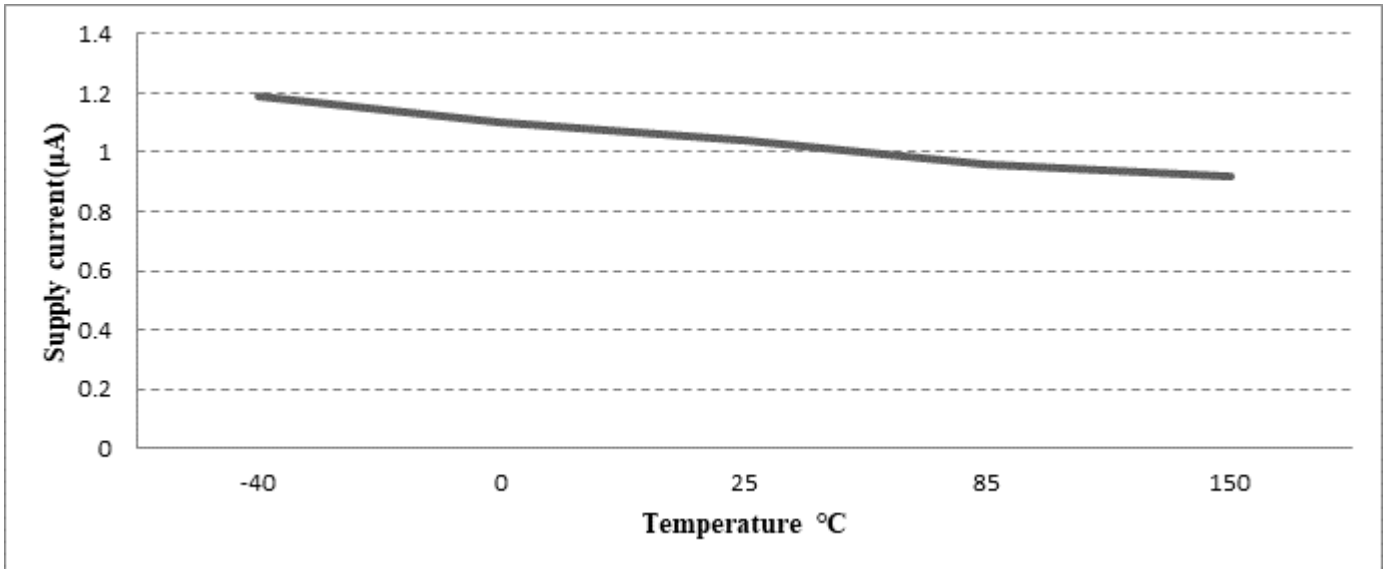

Figure.6 Supply Current vs. Temperature

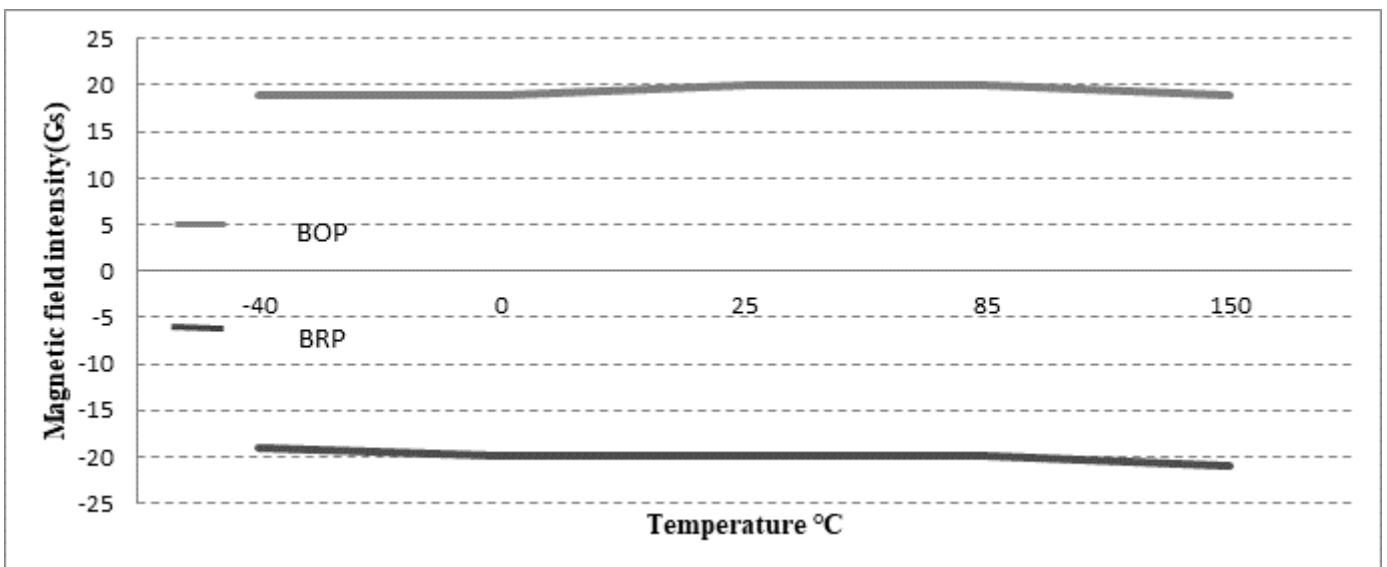

Figure.7 Magnetic Characteristics vs. Temperature (BOP & BRP)

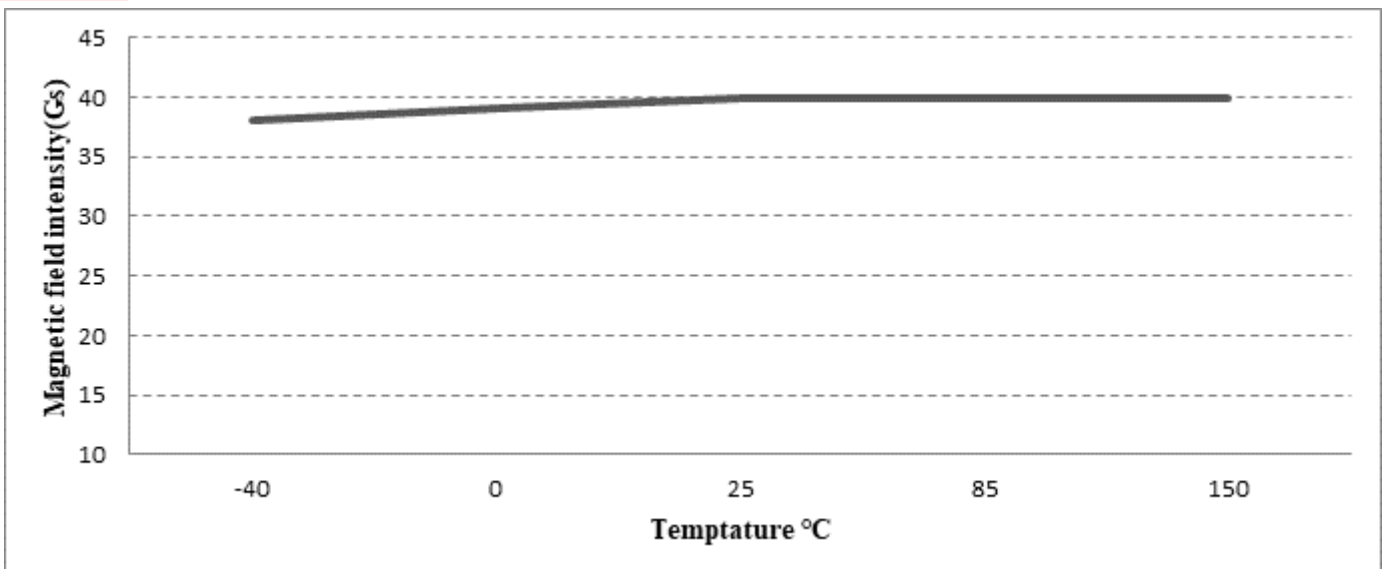

Figure.8 Magnetic Characteristics vs. Temperature (BHYST)

### 10.6 Typical Output Waveform

MT856XA as example

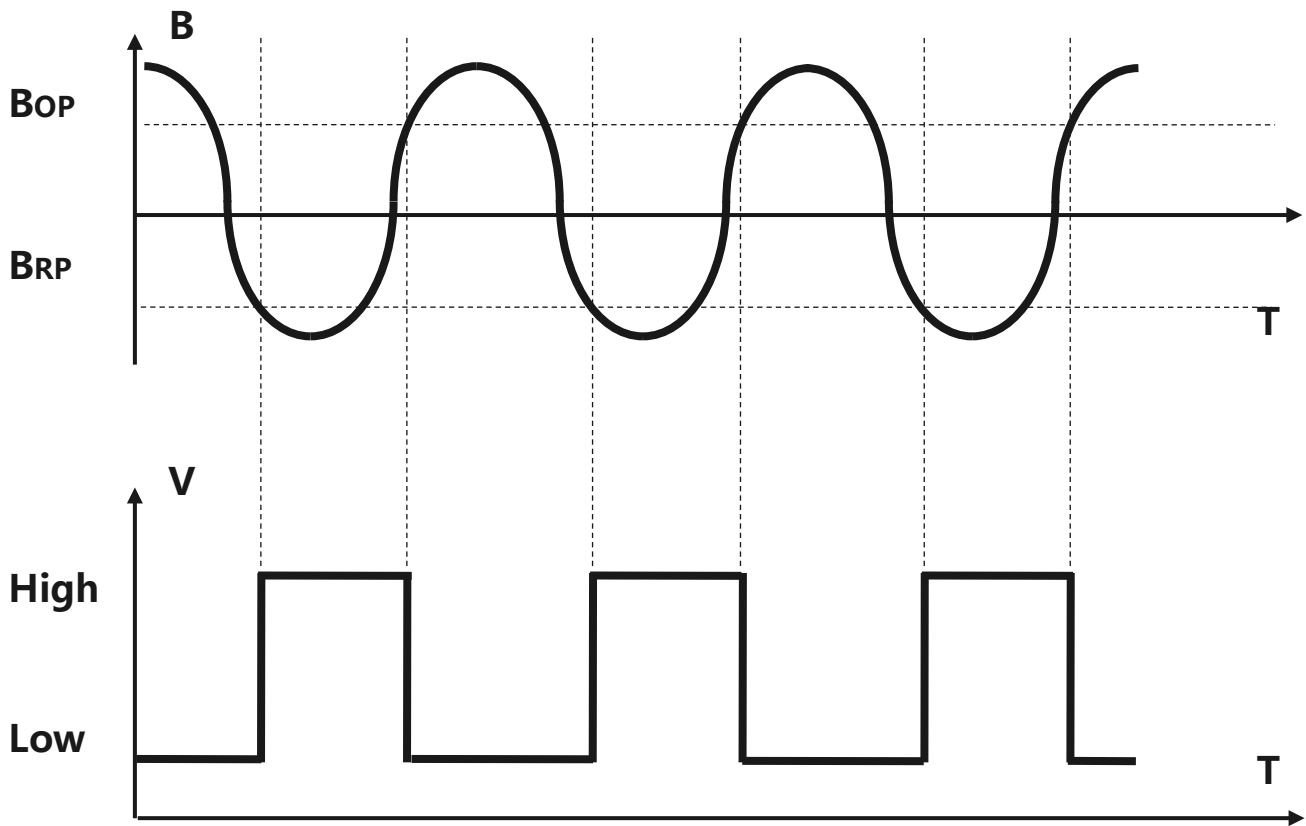

Figure.9 Digital Output vs. Magnetic Flux Density

### 11 Typical Application Circuit

MT856XAT as example

Note: Recommended value for  $R_L$  is 10KOhms

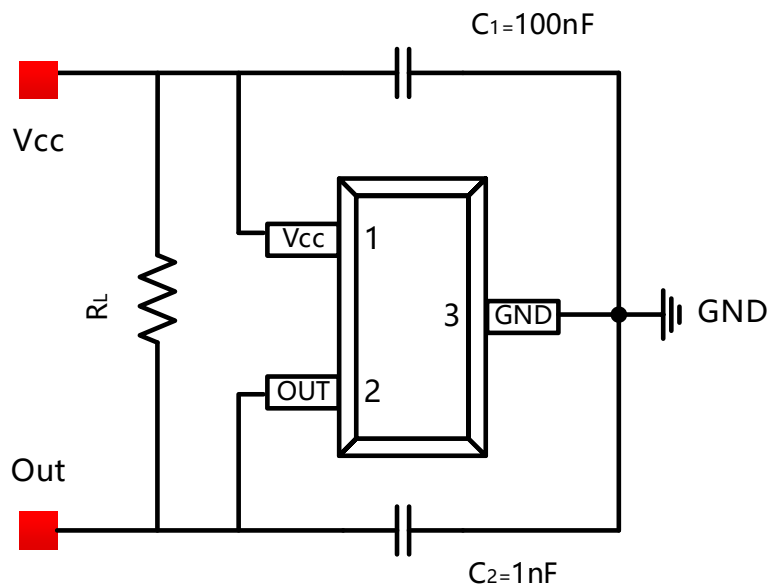

Figure.10 Typical Application Circuit

## 12 Package Material Information (For Reference Only – Not for Tooling Use)

### 12.1 SOT-23 Package Information

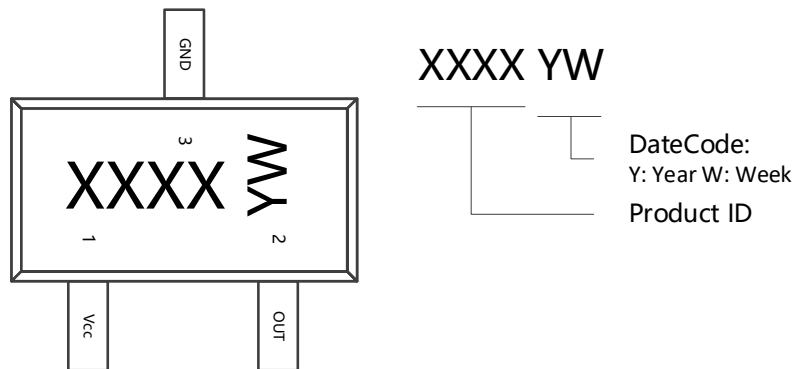

Figure.10 SOT-23 Chip Marking Spec

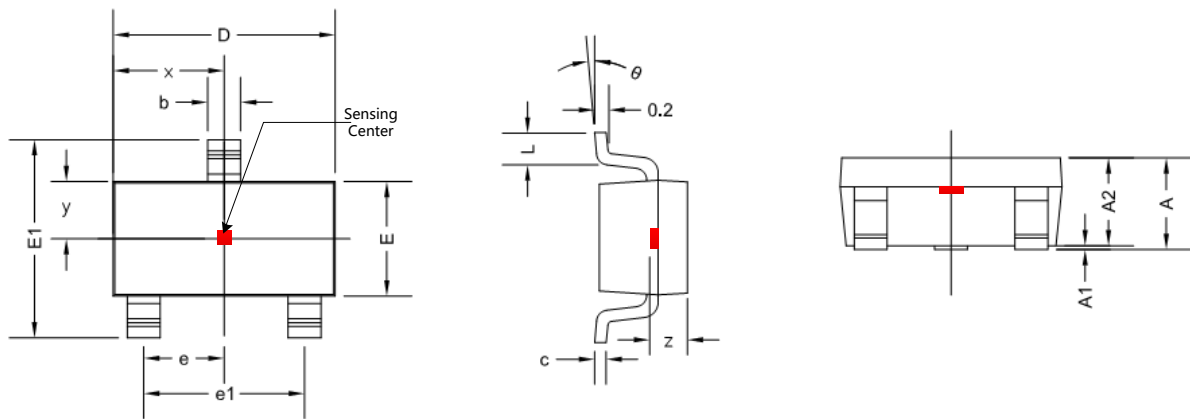

Figure.11 SOT-23 Package Drawing

| Symbol   | Dimensions in Millimeters |       | Dimensions in Inches |       |
|----------|---------------------------|-------|----------------------|-------|
|          | Min                       | Max   | Min                  | Max   |
| A        | 1.050                     | 1.300 | 0.041                | 0.051 |
| A1       | 0.000                     | 0.150 | 0.000                | 0.006 |
| A2       | 1.000                     | 1.200 | 0.039                | 0.047 |
| b        | 0.300                     | 0.500 | 0.012                | 0.020 |
| c        | 0.080                     | 0.220 | 0.003                | 0.009 |
| D        | 2.800                     | 3.020 | 0.110                | 0.119 |
| E        | 1.500                     | 1.700 | 0.059                | 0.067 |
| E1       | 2.600                     | 3.000 | 0.102                | 0.118 |
| e        | 0.950 TYP                 |       | 0.037 TYP            |       |
| e1       | 1.800                     | 2.000 | 0.071                | 0.079 |
| L        | 0.300                     | 0.600 | 0.012                | 0.024 |
| $\theta$ | 0 °                       | 8 °   | 0 °                  | 8 °   |
| x        | 1.460 TYP                 |       | 0.057 TYP            |       |
| y        | 0.800 TYP                 |       | 0.032 TYP            |       |
| z        | 0.600 TYP                 |       | 0.024 TYP            |       |



### 12.2 SOT-23 (Thin Outline) Package Information

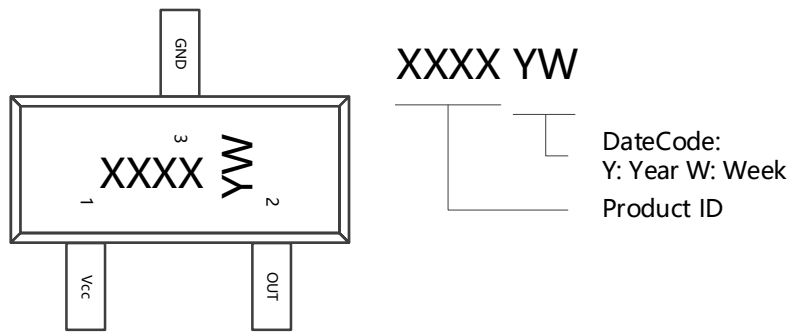

Figure.12 SOT-23 (Thin Outline) Chip Marking Spec

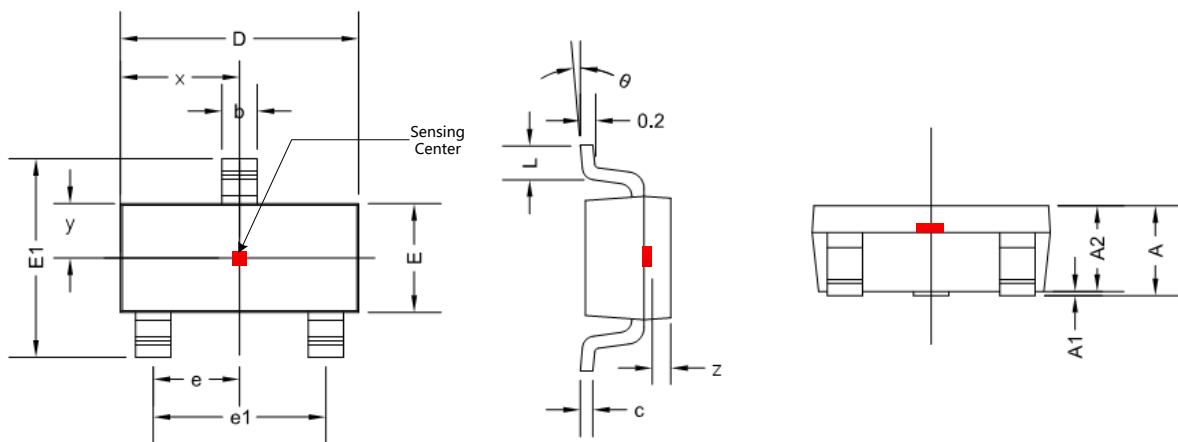

Figure.13 SOT-23 (Thin Outline) Package Drawing

| Symbol   | Dimensions in Millimeters |       | Dimensions in Inches |       |
|----------|---------------------------|-------|----------------------|-------|
|          | Min                       | Max   | Min                  | Max   |
| A        | 0.900                     | 1.150 | 0.035                | 0.045 |
| A1       | 0.000                     | 0.100 | 0.000                | 0.004 |
| A2       | 0.900                     | 1.100 | 0.035                | 0.043 |
| b        | 0.300                     | 0.500 | 0.012                | 0.020 |
| c        | 0.132                     | 0.202 | 0.005                | 0.008 |
| D        | 2.800                     | 3.000 | 0.110                | 0.118 |
| E        | 1.200                     | 1.400 | 0.047                | 0.055 |
| E1       | 2.250                     | 2.550 | 0.089                | 0.100 |
| e        | 0.950 TYP                 |       | 0.037 TYP            |       |
| e1       | 1.800                     | 2.000 | 0.071                | 0.079 |
| L        | 0.550 REF                 |       | 0.022 REF            |       |
| L1       | 0.300                     | 0.500 | 0.012                | 0.020 |
| $\theta$ | 0 °                       | 8 °   | 0 °                  | 8 °   |
| x        | 1.460 TYP                 |       | 0.057 TYP            |       |
| y        | 0.650 TYP                 |       | 0.026 TYP            |       |
| z        | 0.500 TYP                 |       | 0.020 TYP            |       |

### 12.3 Flat TO-92 Package Information

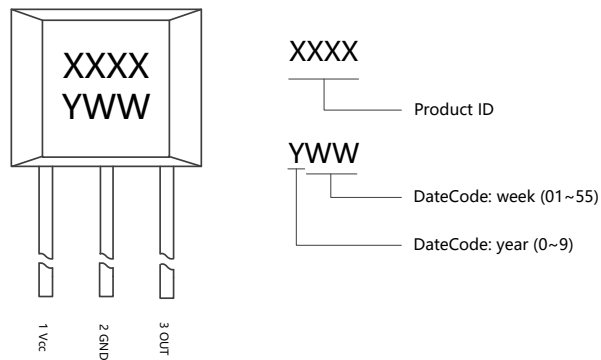

Figure.14 Flat TO-92 Chip Marking Spec

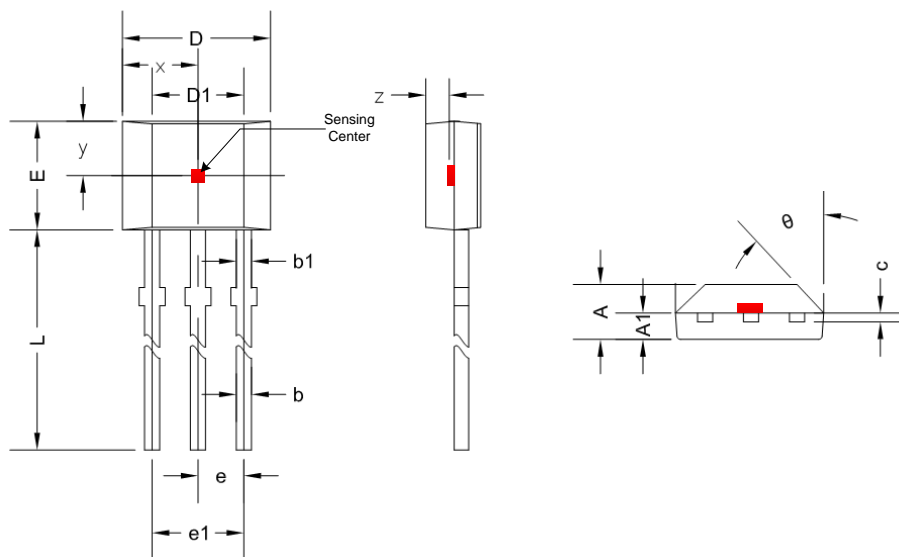

Figure.15 Flat TO-92 Package Drawing

| Symbol | Dimensions in Millimeters |        | Dimensions in Inches |       |
|--------|---------------------------|--------|----------------------|-------|
|        | Min                       | Max    | Min                  | Max   |
| A      | 1.420                     | 1.620  | 0.056                | 0.064 |
| A1     | 0.660                     | 0.910  | 0.026                | 0.036 |
| b      | 0.330                     | 0.560  | 0.013                | 0.022 |
| b1     | 0.400                     | 0.510  | 0.016                | 0.020 |
| c      | 0.330                     | 0.510  | 0.013                | 0.020 |
| D      | 3.900                     | 4.200  | 0.154                | 0.165 |
| D1     | 2.280                     | 2.680  | 0.090                | 0.106 |
| E      | 2.900                     | 3.280  | 0.114                | 0.128 |
| e      | 1.270 TYP                 |        | 0.050 TYP            |       |
| e1     | 2.440                     | 2.640  | 0.096                | 0.104 |
| L      | 13.500                    | 16.200 | 0.531                | 0.638 |
| θ      | 45 ° TYP                  |        | 45 ° TYP             |       |
| x      | 2.025 TYP                 |        | 0.080 TYP            |       |
| y      | 1.545 TYP                 |        | 0.061 TYP            |       |
| z      | 0.500 TYP                 |        | 0.020 TYP            |       |

### 13 Copy Rights and Disclaimer

1. This document may not be reproduced or duplicated, in any form, in whole or in part without prior written consent of MagnTek . Copyrights © 2019, MagnTek Incorporated.
2. MagnTek reserves the right to make changes to the information published in this document at anytime without notice.
3. MagnTek' s products are limited for use in normal commercial applications. MagnTek' s products are not to be used in any device or system, including but not limited to medical life support equipment and system.

For the latest version of this document, please visit our website: [www.magntek.com.cn](http://www.magntek.com.cn)